



PLAFONIERE SPORGENTI Surface mounting fittings



Office SLA - DIF - PAR - PART ₅	164
Office DIF LED	166
Interio	168
Moon	170
Onda IND - DUO - LED	172

PLAFONIERE SPORGENTI

Surface mounting fittings



OFFICE



OFFICE SLA · DIF · PAR · PAR T5

m² 0.018
 415x290x150mm

1 Pcs
 80 pcs

IP20 IP40

	CODICE Code	CABLAGGIO Wiring	POTENZA Power (W)	PORTALAMPADA Lampholder	ESECUZIONE Execution	A (mm)	B (mm)	I (mm)	L (mm)	PESO NETTO Net weight (Kg)	COLORE Colour
SLA	601821.136	FL T8	1x36W	G13	EL	195	1222	850	135	3,34	■
	601821.158	FL T8	1x58W	G13	EL	195	1522	1150	135	4,25	■
	601821.218	FL T8	2x18W	G13	EL	305	622	500	250	2,87	■
	601821.236	FL T8	2x36W	G13	EL	305	1222	850	250	5,06	■
	601821.258	FL T8	2x58W	G13	EL	305	1522	1150	250	7,20	■
	601821.418	FL T8	4x18W	G13	EL	605	622	500	500	5,11	■
DIF	604821.218	FL T8	2x18W	G13	EL	305	622	500	250	3,00	■
	604821.236	FL T8	2x36W	G13	EL	305	1222	850	250	5,80	■
	604821.418	FL T8	4x18W	G13	EL	605	622	500	500	5,40	■
PAR	602821.136	FL T8	1x36W	G13	EL	195	1222	850	135	3,58	■
	602821.158	FL T8	1x58W	G13	EL	195	1522	1150	135	4,64	■
	602821.218	FL T8	2x18W	G13	EL	305	622	500	250	3,07	■
	602821.236	FL T8	2x36W	G13	EL	305	1222	850	250	5,92	■
	602821.258	FL T8	2x58W	G13	EL	305	1522	1150	250	7,80	■
	602821.418	FL T8	4x18W	G13	EL	605	622	500	500	5,45	■
PAR T5	602821.414	FL T5	4x14W	G5	EL	605	622	500	500	4,16	■
	602821.424	FL T5	4x24W	G5	EL	605	622	500	500	4,16	■
	962000.000	Kit di sospensione Suspension kit									
	code + 01	Kit Emergenza 1h 1h emergency kit									
	code + 01	Kit Emergenza 3h 3h emergency kit (escluso/excluded 2x18W)									



Office SLA (IP20)

Corpo: lamiera di acciaio verniciata con polveri epossidiche.
Ottiche disponibili:
SLA: alluminio lucido con traversini rigati;
DIF: diffusore in metacrilato prismatico, cornice in lamiera verniciata;
PAR: dark/light doppia parabolicità in alluminio preanodizzato.
Alimentazione: 220/240V 50/60Hz con reattore elettronico.

Disponibile a richiesta:
 · reattore dimmerabile 1-10V;
 · reattore dimmerabile DALI;
 · kit di emergenza;
 · versione per tubi a LED.



Office DIF (IP40)

Housing: steel sheet painted in epoxy powder.
Available optics:
SLA: polished aluminium with crosswise sleepers;
DIF: prismatic methacrylate diffuser, painted metal sheet frame;
PAR: dark/light preanodized aluminium double parabolic.
Power supply: 220/240V 50/60Hz with electronic ballast.

Available on request:
 · 1-10V dimmable ballast;
 · DALI dimmable ballast;
 · emergency kit;
 · LED tubes version.

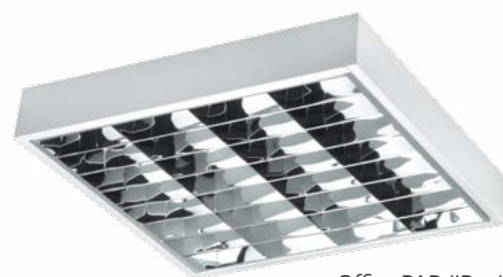

Office PAR (IP20)

COLORI DISPONIBILI
 Available colours

1 Bianco
 White

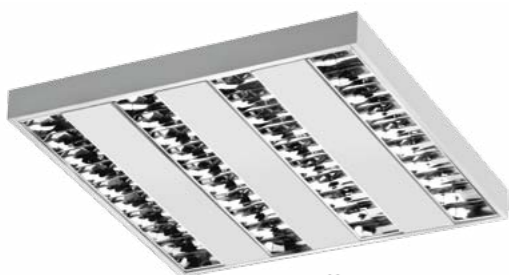

Office PAR T5 (IP20)



Kit di sospensione | Suspension kit

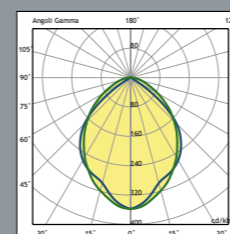
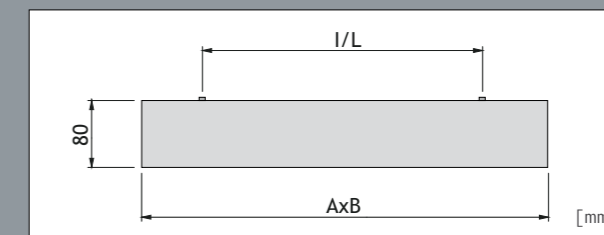

SLA FL 2x36W G13

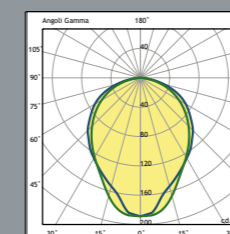

DIF FL 2x18W G13

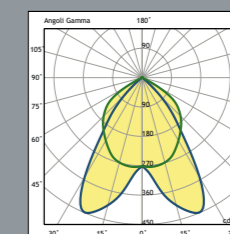

PAR FL 2x36W G13

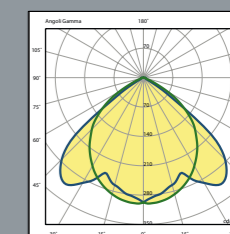

PAR T5 4x24W



OFFICE DIF LED



Corpo: lamiera di acciaio verniciata con polveri epossidiche.
Ottica DIF: diffusore in metacrilato prismaticizzato cornice in lamiera verniciata.

Moduli LED: alimentati a 500mA, colore 4000K.

Alimentazione: 220/240V 50/60Hz con reattore elettronico.

Disponibile a richiesta:

- reattore dimmerabile 1-10V;
- reattore dimmerabile DALI;
- kit di emergenza.

Housing: steel sheet painted in epoxy powder.

Optic DIF: prismatic methacrylate diffuser, painted metal sheet frame.

LED modules: 500mA current, 4000K colour.

Power supply: 220/240V 50/60Hz with electronic ballast.

Available on request:

- 1-10V dimmable ballast;
- DALI dimmable ballast;
- emergency kit.

COLORI DISPONIBILI
Available colours

- 1 Bianco
White

OFFICE DIF LED



CODICE Code	CABLAGGIO Wiring	POTENZA Power(W)	FLUSSO NOM. Typical Flux(lm)	COLORE LED Beam color(K)	CORRENTE Current(A)	A (mm)	B (mm)	I (mm)	L (mm)	PESO NETTO Net weight(Kg)	SORGENTE Light source	COLORE Colour
604641.218	LED BAR	24W	3400	4000	0,5	305	622	500	250	2,80	LITEON	■
604641.236	LED BAR	48W	6800	4000	0,5	305	1222	850	250	5,00	LITEON	■
604641.258	LED BAR	60W	8500	4000	0,5	305	1522	1150	250	7,00	LITEON	■
604641.418	LED BAR	48W	6800	4000	0,5	605	622	500	500	5,00	LITEON	■
962000.000	Kit di sospensione Suspension kit											
code + 01	Kit Emergenza 1h 1h emergency kit											
code + 03	Kit Emergenza 3h 3h emergency kit (escluso/excluded 24W)											



Kit di sospensione
Suspension kit

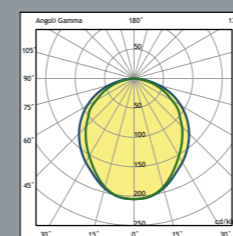

LED BAR 48W

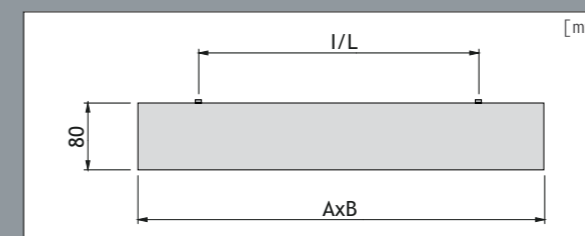

LED BAR



INTERIO



Corpo: lamiera di acciaio verniciata con polveri epossidiche di colore bianco.

Diffusore: policarbonato antiurto, stabilizzato ai raggi UV, finitura opale.

Testate di chiusura: ABS stabilizzato ai raggi UV, colore bianco.

Alimentazione: 220/240V 50/60Hz con reattore elettronico.

Disponibile a richiesta:

- reattore dimmerabile 1-10V;
- reattore dimmerabile DALI;
- kit di emergenza ;
- versione per tubi a LED.

Housing: steel sheet painted in white epoxy powder.

Diffuser: opal polycarbonate shockproof, UV stabilized.

Closing heads: ABS UV stabilized, white colour.

Power supply: 220/240V 50/60Hz with electronic ballast.

Available on request:

- 1-10V dimmable ballast,
- DALI dimmable ballast ;
- emergency kit;
- LED tubes version.

COLORI DISPONIBILI

Available colours

- 1 Bianco
White

INTERIO



CODICE Code	CABLAGGIO Wiring	POTENZA Power (W)	PORTALAMPADA Lampholder	ESECUZIONE Execution	A (mm)	B (mm)	PESO NETTO Net weight(Kg)	COLORE Colour
606821.118	FL T8	1x18W	G13	EL	635	450	0,56	■
606821.136	FL T8	1x36W	G13	EL	1240	900	1,12	■
606821.158	FL T8	1x58W	G13	EL	1540	900	1,31	■
606821.218	FL T8	2x18W	G13	EL	635	450	0,96	■
606821.236	FL T8	2x36W	G13	EL	1240	900	1,56	■
606821.258	FL T8	2x58W	G13	EL	1540	900	1,92	■
606821.114	FL T5	1x14W	G5	EL	635	450	0,56	■
606821.128	FL T5	1x28W	G5	EL	1240	900	1,20	■
606821.135	FL T5	1x35W	G5	EL	1540	900	1,59	■
606821.124	FL T5	1x24W	G5	EL	635	450	0,56	■
606821.154	FL T5	1x54W	G5	EL	1240	900	1,35	■
606821.149	FL T5	1x49W	G5	EL	1540	900	1,31	■
606821.180	FL T5	1x80W	G5	EL	1540	900	1,31	■
606821.214	FL T5	2x14W	G5	EL	635	450	0,80	■
606821.228	FL T5	2x28W	G5	EL	1240	900	1,53	■
606821.235	FL T5	2x35W	G5	EL	1540	900	1,82	■
606821.224	FL T5	2x24W	G5	EL	635	450	0,71	■
606821.254	FL T5	2x54W	G5	EL	1240	900	1,34	■
606821.249	FL T5	2x49W	G5	EL	1540	900	1,92	■
606821.280	FL T5	2x80W	G5	EL	1540	900	2,00	■
code + 01 Kit Emergenza 1h 1h emergency kit 2x36/58W								
code + 01 Kit Emergenza 1h 1h emergency kit 2x18/35/49/54/80W								

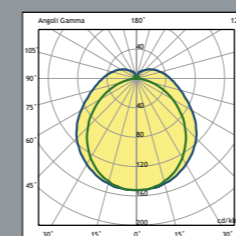

FL 2x58W EL

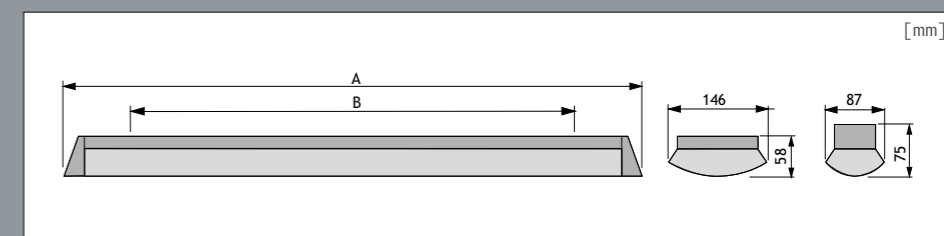



MOON



Corpo: stampato in ABS di colore bianco.
Diffusore: policarbonato antiurto, stabilizzato ai raggi UV, finitura bucciata.
Modulo LED: da 10 e 18W, 3000/4000K.
Alimentazione: 220/240V 50/60Hz con reattore elettronico.

Disponibile a richiesta:
 · kit emergenza;
 · sensore di presenza.

Body: molded in white ABS.
Diffuser: impact resistant polycarbonate, UV stabilized, textured finishing.
LED module: 10 and 18W, 3000/4000K.
Power supply: 220/240V 50/60Hz with electronic ballast.

Available on request:
 · emergency kit;
 · HF Sensor.

COLORI DISPONIBILI
 Available colours

- 1 Bianco
White

MOON

m² 0.012
 325x325x110mm

1 Pcs
 70 pcs



CODICE Code	CABLAGGIO Wiring	POTENZA Power(W)	FLUSSO NOM. Typical Flux(lm)	COLORE LED Beam color(K)	PESO NETTO Net weight(Kg)	SORGENTE Light source	COLORE Colour
620641.103	LED	10W	1250	3000	1,00	LED	■
620641.104	LED	10W	1250	4000	1,00	LED	■
620641.113	LED + HF SENSOR	10W	1250	3000	1,00	LED	■
620641.114	LED + HF SENSOR	10W	1250	4000	1,00	LED	■
620641.203	LED	18W	2275	3000	1,30	LED	■
620641.204	LED	18W	2275	4000	1,30	LED	■
620641.213	LED + HF SENSOR	18W	2275	3000	1,30	LED	■
620641.214	LED + HF SENSOR	18W	2275	4000	1,30	LED	■

code + 01 Kit Emergenza 3h | 3h emergency kit (disponibile su/available on 18W)

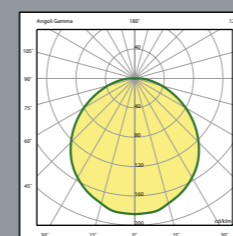

LED 10W 3000K

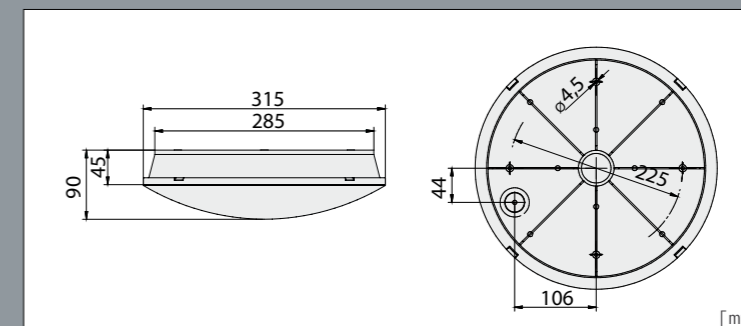

[mm]

PLAFONIERE SPORGENTI
Surface mounting fittings



ONDA

ONDA IND · DUO · LED

m² 0.043
650x635x105mm

1 Pcs
40 pcs



	CODICE Code	CABLAGGIO Wiring	POTENZA Power(W)	PORTALAMPADA Lampholder	ESECUZIONE Execution	FLUSSO NOM. Typical Flux(lm)	COLORE LED Beam color(K)	CURRENT Current(A)	PESO NETTO Net weight(Kg)	SORGENTE Light source	COLORE Colour
IND	607821.236	FLC	2x36W	2G11	EL				6,69		■
	607821.240	FLC	2x40W	2G11	EL				6,69		■
	607821.255	FLC	2x55W	2G11	EL				6,69		■
IND LED	607641.524	LED	52W		LED	6670	4000	0,7	6,69	VOSSLOH	■
DUO	608821.236	FLC	2x36W	2G11	EL				6,79		■
	608821.240	FLC	2x40W	2G11	EL				6,79		■
	608821.255	FLC	2x55W	2G11	EL				6,79		■
DUO LED	608641.524	LED	52W		LED	6670	4000	0,7	6,69	VOSSLOH	■
	code + 01	Kit Emergenza 1h/3h 1h/3h emergency kit									
	code + 01	Kit Emergenza LED 1h/3h 1h/3h LED emergency kit									



Onda IND

Corpo: lamiera di acciaio verniciata con polveri epossidiche.
Ottiche disponibili:
IND: lamiera di acciaio verniciata con polveri epossidiche di colore bianco;
DUO: lamiera di acciaio microforato per un'illuminazione diretta ed indiretta.
Moduli LED: alimentati a 700mA, colore 4000K.
Alimentazione: 220/240V 50/60Hz con reattore elettronico.

Disponibile a richiesta:
· kit emergenza.



Onda DUO

Housing: steel sheet painted in epoxy powder.
Available optics:
IND: white painted epoxy powder steel;
DUO: steel sheet tray for direct and indirect lighting.
LED modules: 700mA current, 4000K colour.
Power supply: 220/240V 50/60Hz with electronic ballast.

Available on request:
· emergency kit.

COLORI DISPONIBILI Available colours

1 Bianco
White

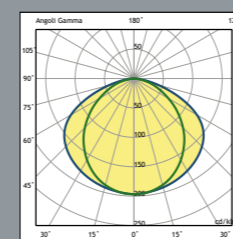

IND FLC 2x55W 2G11

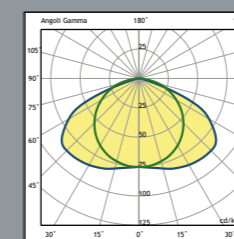

DUO FLC 2x36W 2G11

